

**1905nm Infrared Diode Low Noise Laser**



†**Specifications**

Product Code	SSL - 1905 - XXXX - LN
Wavelength [ nm ]	1905 ±5
Output Power [ mW ]	1 - 500
Transverse Mode	TE <sub>00</sub> / CW
Operating Temperature [ °C ]	+10 - +35
Storage Temperatures [ °C ]	-10 - +45
Warm-up Time [ minutes ]	< 5
Power Stability [ rms, over 4 hours ]	5%, 3%, 1%
M <sup>2</sup> Factor	< 15
Beam Diameter At The Aperture [ mm ]	~ 4.0 × 6.0
Beam Divergence, Full Angle [ mrad ]	< 2.5
Spectral Linewidth [ nm ]	< 1.0
Polarization Ratio	> 50 : 1
Point Stability After Warm-up [ mrad ]	< 0.05
Noise of Amplitude [ rms ]	< 1%
Laser Head Dimensions [ mm ]	160 [L] × 78 [W] × 60 [H]
Power Supply Dimensions [ mm ]	235 [L] × 145 [W] × 100 [H]
Working Voltage [ VAC ]	85~245, 50/60Hz
Laser Gross Weight [ kg ]	3.0
Cooling Way	Cooled by TEC and air
Expected Lifetime [ hours ]	> 10000
Warranty Time [ year ]	1

**Laser Head Dimension:**

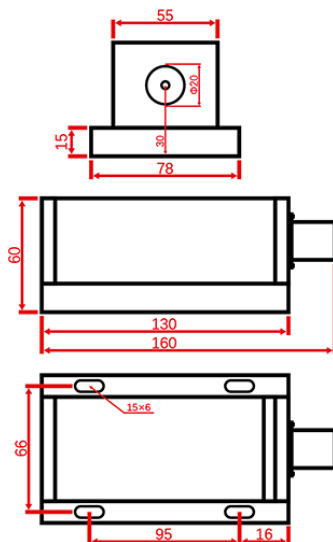

**Power Supply Dimension:**

