

780nm Infrared Diode Low Noise Laser



†**Specifications**

Product Code	SSL - 780 - XXXX - LN
Wavelength [nm]	780 ±5
Output Power [mW]	1 - 2500
Transverse Mode	TE ₀₀ / CW
Operating Temperature [°C]	+10 - +35
Storage Temperatures [°C]	-10 - +45
Warm-up Time [minutes]	< 5
Power Stability [rms, over 4 hours]	5%, 3%, 1%
M² Factor	< 15
Beam Diameter At The Aperture [mm]	~ 4.0 × 5.0
Beam Divergence, Full Angle [mrad]	< 2.0
Spectral Linewidth [nm]	< 1.0
Polarization Ratio	> 50 : 1
Point Stability After Warm-up [mrad]	< 0.05
Noise of Amplitude [rms]	< 1%
Laser Head Dimensions [mm]	135 [L] × 75 [W] × 45 [H]
Power Supply Dimensions [mm]	130 [L] × 120 [W] × 55 [H]
Working Voltage [VAC]	85~245, 50/60Hz
Laser Gross Weight [kg]	1.5
Cooling Way	Cooled by TEC and air
Expected Lifetime [hours]	> 10000
Warranty Time [year]	1

Laser Head Dimension:

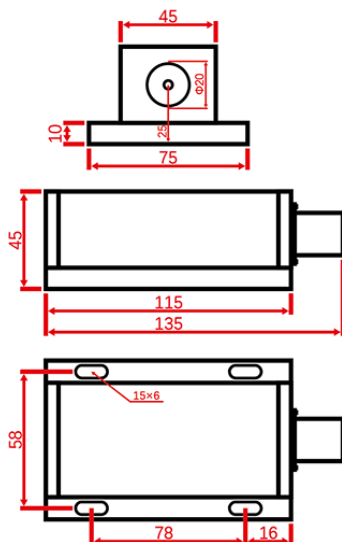

Power Supply Dimension:

