

## 975nm Infrared Diode Low Noise Laser



### †Specifications

Product Code	SSL - 975 - XXXX - LN - LED
Wavelength [ nm ]	975 ±5
Output Power [ mW ] [ 0 - Max Adjustable ]	3000 - 5000
Transverse Mode	TE <sub>00</sub> / CW
Operating Temperature [ °C ]	+10 - +35
Storage Temperatures [ °C ]	-10 - +45
Warm-up Time [ minutes ]	< 5
Power Stability [ rms, over 4 hours ]	5%, 3%, 1%
M <sup>2</sup> Factor	< 15
Beam Diameter At The Aperture [ mm ]	~ 4.0 × 6.0
Beam Divergence, Full Angle [ mrad ]	< 2.5
Spectral Linewidth [ nm ]	< 1.0
Polarization Ratio	> 50 : 1
Point Stability After Warm-up [ mrad ]	< 0.05
Noise of Amplitude [ rms ]	< 1%
Laser Head Dimensions [ mm ]	160 [L] × 78 [W] × 60 [H]
Power Supply Dimensions [ mm ]	260 [L] × 145 [W] × 105 [H]
Working Voltage [ VAC ]	85~245, 50/60Hz
Laser Gross Weight [ kg ]	3.5
Cooling Way	Cooled by TEC and air
Expected Lifetime [ hours ]	> 10000
Warranty Time [ year ]	1

#### Laser Head Dimension:

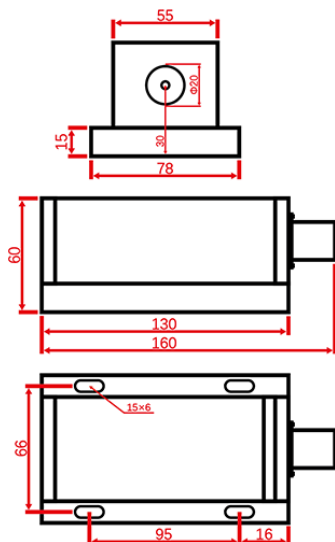

#### Power Supply Dimension:

